

P-953

**AM/FM/MPX RADIO WITH FOLD-DOWN
DETACHABLE FRONT PANEL,
COMPACT DISC PLAYER,
AUXILIARY AUDIO INPUT, MP3 CD PLAYBACK,
CD CHANGER CONTROLS,
WIRELESS REMOTE CONTROL
AND QUARTZ CLOCK**



**OWNER'S
MANUAL**

Released 6-14-02

INDEX

	Page
<i>Operating Instructions</i>	3 - 9
<i>Setting the Clock</i>	9
<i>CD Player Error Codes</i>	9
<i>Specifications</i>	10
<i>CD Changer Controls</i>	11
<i>CD Changer Error Codes</i>	12
<i>Wireless Remote Control Operation</i>	13
<i>Playing MP3 Music Files</i>	14
<i>Notes on Discs</i>	17
<i>Care and Maintenance</i>	18
<i>Warranty</i>	19

OPERATING INSTRUCTIONS

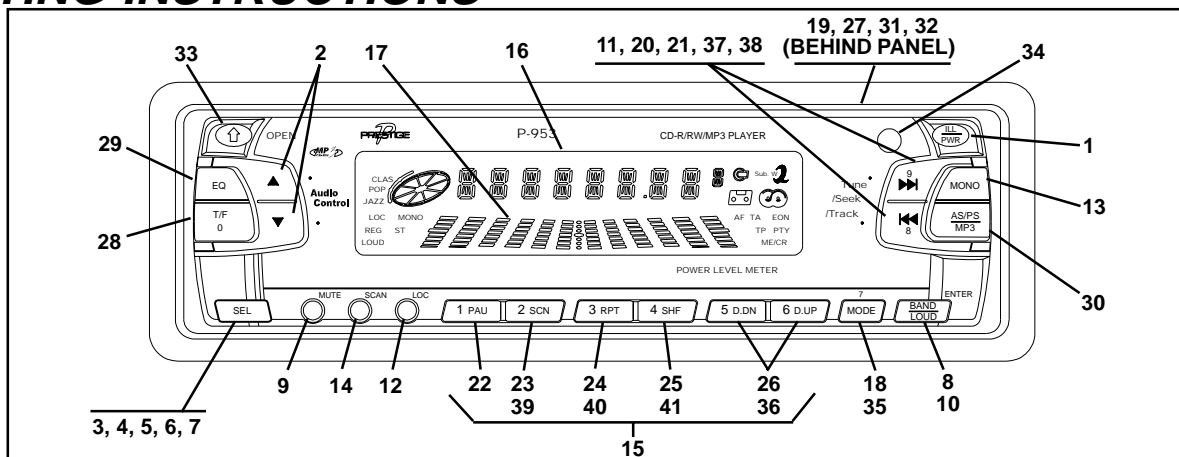

① POWER ON-OFF/ILLUMINATION (PWR/ILL) BUTTON

Press this button to turn the unit on or off. If the ignition switch is "on", the unit will also turn on automatically when a compact disc is inserted, or if any other switch is pressed.

When the unit is on, each time the button is momentarily pressed and released, the VFD display panel back-lighting intensity will change from low-to-medium-to-high, and then back to low, thereby providing three different intensity settings. When the unit is turned off, the time-of-day is continuously displayed.

② AUDIO CONTROL (▲/▼) BUTTONS

To increase the volume level, press the ▲ button. The volume will increase and the level will be shown on the display panel from a minimum of **VOL 00** to a maximum of **VOL 100**. To decrease the volume level, press the ▼ button. The display will automatically return to the normal indication 5 seconds after the last volume adjustment or when another function is activated. These control buttons are also

used in conjunction with the Select (SEL) button ③ to adjust the bass, treble, balance and fader levels as described in ④, ⑤, ⑥ and ⑦.

③ PUSH SELECT CONTROL BUTTON (SEL)

This button is used to select the audio function (volume, bass, treble, balance, or fade) whose setting is adjusted using the AUDIO CONTROL buttons ②. Pressing the SEL button once will set the unit for volume adjustment (**VOL** on the display). Pressing the button additional times will select bass adjustment (**BAS** on the display), treble adjustment (**TRB** on the display), balance (**BAL**), or fader (**FAD**). The display will automatically return to the normal indication 5 seconds after the last adjustment or when another function is activated.

NOTE: If the BAS or TRB functions are set while the Equalizer function ⑨ is active, the Equalizer function will automatically revert to the **FLAT** setting.

④ BASS CONTROL

To adjust the bass level (Equalizer function inactive), first select the Bass mode by pressing the SEL button ③ so the **BAS** indication appears on the display panel. Within 5 seconds of choosing the Bass mode, press the ▼ AUDIO CONTROL ② button to decrease the bass response, or the ▲ AUDIO CONTROL button to increase it as desired. The level will be shown on the display panel from a minimum **BAS --10** to a maximum of **BAS 10** (**BAS 00** indicates flat response). The display will automatically return to the normal indication 5 seconds after the last adjustment or when another function is activated.

⑤ TREBLE CONTROL

To adjust the treble level (Equalizer function inactive), first select the Treble mode by pressing the SEL button ③ so the **TRB** indication appears on the display panel. Within 5 seconds of choosing the Treble mode, press the ▼ AUDIO CONTROL button ② to decrease the treble response or the ▲ AUDIO CONTROL button to increase it as desired. The level will be shown on the display panel from a minimum **TRB --10** to a maximum of **TRB 10** (**TRB 00** indicates flat response). The display will automatically return to the normal indication 5 seconds after the last adjustment or when another function is activated.

⑥ LEFT/RIGHT BALANCE CONTROL

To adjust the left-right speaker balance, first select the Balance mode by pressing the SEL button ③ so the **BAL** indication appears on the display panel. Within 5 seconds of choosing the Balance mode, press the ▼ AUDIO CONTROL button ② to adjust the stereo balance to the left channel speakers or the ▲ AUDIO CONTROL button to adjust it to the right channel speakers. The balance position will be shown on the display panel from **BAL 10L** (full left) to **BAL**

10R (full right). When the volume level between the left and right speakers is equal, **BAL L=R** will be shown on the display panel. The display will automatically return to the normal indication 5 seconds after the last adjustment or when another function is activated.

⑦ FRONT/REAR FADER CONTROL

To adjust the front-rear speaker balance, first select the Fader mode by pressing the SEL button ③ so the **FAD** indication appears on the display panel. Within 5 seconds of choosing the Fader mode, press the ▼ AUDIO CONTROL button ② to adjust the front-rear speaker balance to the front speakers or the ▲ AUDIO CONTROL button to adjust it to the rear speakers. The fader position will be shown on the display panel from **FAD 10R** (full rear) to **FAD 10F** (full front). When the level between the front and rear speakers is equal, **FAD F=R** will be shown on the display panel. The display will automatically return to the normal indication 5 seconds after the last adjustment or when another function is activated.

⑧ LOUDNESS CONTOUR (LOUD)

When listening to music at low volume levels, this feature will boost the bass and treble ranges to compensate for the characteristics of human hearing. Press and hold the BAND/LOUD button for 2 seconds to activate this feature; the unit will beep and **LOUD ON** will appear on the display for 5 seconds. Pressing the button again for 2 seconds will deactivate the feature; the unit will beep and **LOUD OFF** will appear on the display panel for 5 seconds.

⑨ AUDIO MUTE SELECTOR (MUTE)

Press this button momentarily to mute the volume from the system (**MUTE** will appear blinking on the display panel). Pressing the button again or activating any other button/function will return to the volume level setting in use before the Mute function was activated. During

disc play, pressing this button will mute disc audio and disc play will be paused. During this time, the  indication will remain on the display panel to show that a disc is still loaded in the unit.

⑩ AM/FM BAND SELECTOR (BAND)

Each time the BAND/LOUD button is pressed momentarily, the radio band is changed. The indication **AM**, **F1**, **F2** or **F3** will appear on the display panel according to your selection.

⑪ UP/DOWN TUNE/SEEK/TRACK (▶▶/◀◀) BUTTONS

To manually select a radio station, momentarily press the Up Tuning (▶▶) button to advance the unit higher, or the Down Tuning (◀◀) button to tune lower within the selected band. The radio will automatically tune to the next strong station and stop on this frequency. If the LOCAL mode is in effect, the radio will seek the next local station and stop at that frequency.

Pressing either button for longer than 2 seconds will cause **MANUAL** to appear on the display, accompanied by a beep tone, thereby entering the seek mode. Pressing a button in this mode will cause the radio to rapidly tune in the up or down direction and stop when the button is released. The radio will then remain at that frequency. Five seconds after Manual tune is inactive, **AUTO** will momentarily appear for 2 seconds, thereby reverting to the normal tuning mode.

⑫ LOCAL (LOC) BUTTON

This feature is used to select the strength of the signals at which the radio will stop during Automatic Seek Tuning. Pressing and this button will select the Local setting (**LOCAL** will appear on the display panel) and only strong (local) stations will be received. Pressing the button again will select the normal Distant setting (**LOCAL** will disappear from the display panel, and **Dx** will be displayed instead) and the radio will stop at a wider range of signals, including weaker (more distant) stations.

⑬ FM MONO/STEREO BUTTON (MONO)

During FM radio operation, this button is used to select mono or stereo reception of the broadcast signal. Under normal reception conditions, the unit should be left in the stereo mode as indicated by the **ST** indication on the display panel when tuned to an FM stereo signal. If the stereo signal is too noisy for comfortable listening, press the MONO button to switch to mono reception (the **ST** indication will disappear from the display panel, and **MONO** will be displayed). To return to stereo reception mode, press the button again so that the **ST** indication reappears in the display.

⑭ LOCAL STATION SCAN (SCAN) BUTTON

Press this button momentarily to commence an scan of the nearby local stations whose signal strengths are the strongest (the station number will appear flashing on the display panel during station search). Press the button again momentarily to stop the Scan operation and remain on the current local frequency. To return to one of the frequencies preset into the current band, press the desired pre-set button.

⑮ STATION PRE-SET MEMORIES

To set any of the 6 pre-set memories in each band, use the following procedure:

1. Turn the radio on and select the desired band.
2. Select the first station to be pre-set using the Manual TUNE or Automatic SEEK Controls ⑪.
3. Press the pre-set button to be set and continue to hold it in for approximately 2 seconds. The preset number will appear on the display panel and a beep will sound, indicating that the station is now set into that preset memory position. The station can now be recalled at any time by pressing that button.

4. Repeat the above procedure for the remaining 5 pre-sets on that band and for the other 3 bands on the unit.

16 VACUUM FLUORESCENT DISPLAY (VFD)

The Vacuum Fluorescent Display (VFD) panel displays the frequency, time, and activated functions using one of three illumination levels as selected by the PWR/ILL button ①.



17 POWER LEVEL METER DISPLAY

This display consists of a left and right six-bar graph which provides a visual representation of the audio signal level. As the signal increases, the number of illuminated segments will increase and vice-versa.

18 MODE SELECTOR (MODE)

This button is used to select the radio, CD player, auxiliary (AUX) input or CD changer (if installed) playback mode. Each press of the button will select a different mode as indicated on the display panel. During CD player operation, this button may be used to change to radio, CD player, AUX input (MP3 or external CD player) or CD changer mode without ejecting the disc. The DISC indication will remain on the display panel to show that the CD changer is operating. Press the button again to return to the desired mode.

19 DISC SLOT

With the front panel in the fold-down position, gently insert the disc into the slot (label surface facing up) until the soft-loading mechanism engages and pulls the disc in. The **S--CDP** indication will appear on the display panel for 5 seconds. The  indication illuminates and becomes animated, the  symbol lights, and the track number appears on the display panel.

CAUTION: This unit is designed for play of standard 5" (12cm) compact discs ONLY. Do not attempt to use 3" (8cm) CD-Singles in this unit, either with or without an adapter, as damage to the player and/or disc can occur. Such damage will not be covered by the Warranty on this product.

20 TRACK SELECT (▶▶/◀◀)

The Track Select function of the TUNE/SEEK/TRACK buttons are used to quickly access the beginning of a particular track when a disc is in play. Each time the Forward TRACK Select (▶▶) side of the button is pressed, the next higher track number will be selected as shown on the display panel. Similarly, each time the Backward TRACK Select (◀◀) side of the button is pressed, the next lower track number will be selected as shown on the display panel.

21 CUE/REVIEW FUNCTIONS (▶▶/◀◀)

High-speed audible search to any section of the disc can be made by the Cue and Review functions. Press and hold the Cue (▶▶) side of the button to advance rapidly in the forward direction (the advancing disc playing time will be shown on the display panel, except for discs formatted with MP3 audio), or the Review (◀◀) button to advance rapidly in the backward direction (the decreasing disc playing time will be shown on the display panel, except for discs formatted with MP3 audio).

⑳ PAUSE (PAU) BUTTON

The Pause function is used to freeze disc play when the CD player or optional CD changer is in use. **S--PAUSE** will appear on the display. Press this button again to resume disc play from the point at which it was stopped and **S--PAUSE** will disappear.

㉑ TRACK SCAN (SCN) SELECT

During disc play, press this button to play the first 10 seconds of each track on the disc (**S--SCN** will appear on the display panel). When a desired track is reached, press the SCN button again to cancel the function (**S--SCN** will disappear from the display panel) and play of the selected track will continue. Scan mode will also be canceled by activating Repeat Play ㉒, or Shuffle Play ㉓.

㉒ REPEAT PLAY (RPT) SELECT

During disc play, press this button to repeat the play of the selected track (**S--RPT** will appear on the display panel). Play of the track will continue to repeat until the button is pressed again and the **S--RPT** indication disappears from the display panel. Repeat Play mode will also be canceled by activating the Track Scan ㉑ or Shuffle Play ㉓ functions.

㉓ SHUFFLE PLAY (SHF) SELECT

During disc play, press this button to play the tracks on the disc in a random shuffled order (**S--SHF** will appear on the display panel). In Shuffle Play mode, the TRACK Select function ㉐ will also select tracks in the random order instead of the normal progression. The Shuffle Play mode can be canceled by pressing the button again (**S--SHF** indication will disappear from the display panel) or by activating the Repeat Play ㉒ or Track Scan ㉑ functions.

㉔ DISC SELECT UP/DOWN (D.UP/D.DN)

These buttons are used to select the desired disc for play during changer operation. To advance to a higher number disc, press the

D.UP button, and to return to a lower number disc, press the D.DN button. The number of the disc in play will be shown on the display panel.

㉕ DISC EJECT (▲)

Disc play is stopped and the disc is ejected when the front panel is folded down and this button on the rear of the panel is pressed. Radio or CD changer operation will automatically resume depending on which mode was in operation prior to disc play. If the disc is not removed from the unit within 15 seconds of being ejected, it will automatically be re-loaded into the unit to prevent it from being accidentally damaged (Ⓢ will appear on the display panel to indicate that a disc is loaded in the player). Play of the disc can be resumed by using the MODE button ㉘ to choose the CD player function.

㉖ TIME/FREQUENCY (T/F) DISPLAY BUTTON

During radio operation, press this button to call the time display on the incorporated quartz clock. The current time will appear together with an **A** or **P** indication. The display will return to the radio frequency indication after 5 seconds.

During disc play, press this button will call the time display. The display will return to the disc indication after 5 seconds.

㉗ EQUALIZER BUTTON (EQ)

The **EQ** button applies preset sound effects to the unit's audio output signal. The **EQ** button, when pressed, will activate one of the following operating modes: **CLASSICS**, **POP M**, **JAZZ**, **DSP OFF** or **FLAT**. Even though the **EQ** function is active, as displayed on the panel, if the bass and/or treble level is set, the **EQ** function automatically returns to the **FLAT** mode. Conversely, when the Equalizer function is not active, the unit returns to the user set bass and treble levels.

30 PRE-SET SCAN (PS) /AUTO-STORE TUNING (AS)

Press this button momentarily to scan the stations pre-set into the six memories of the current band in use. The unit will stop at each pre-set station for 5 seconds before continuing to the next pre-set station (the pre-set number on the display panel will flash during Pre-Set Scan operation). Press the button again momentarily to stop Pre-Set Scan operation and remain on the selected frequency.

Pressing and holding the button for longer than 2 seconds will activate the Auto-Store Tuning feature which will automatically scan and enter up to 6 stations into the pre-set memories of each FM band and the AM band. If you have already set the pre-set memories to your favorite stations, activating the Auto-Store Tuning feature will erase those stations and enter the new ones. This feature is most useful when traveling in a new area where you are not familiar with the local stations.

31 THEFT-DETERRENT LED

Located on the chassis behind the front panel, a light-emitting diode (LED) will flash when the panel is physically removed. The flashing light serves as a visual warning to the would-be thief that the unit has been disabled by removal of the front panel.

32 RESET BUTTON

The RESET button is located to the right of the theft deterrent LED. The reset circuitry should only be activated under the following circumstances as it will erase the time and pre-set memories:

1. Upon initial installation after all wiring is completed.
2. If there is a malfunction of any of the switches on the unit, pressing the RESET button may clear the system and return to normal operation.

33 FRONT PANEL RELEASE BUTTON (OPEN)

This button is used to release the mechanism that holds the front panel to the chassis. To detach the front panel, press the button so that the panel drops to the lowered position. Grasp the panel at the middle and pull it off of the chassis. To re-attach the panel, press it straight onto the chassis until the mechanism locks it into place.

34 REMOTE SENSOR

The sensor to detect the infrared signal from the wireless remote control is located behind the VFD display lens. For optimum operation of the remote control, always aim the control at the VFD display.

NOTES ON USE OF FRONT PANEL

1. Make sure the front panel is positioned correctly when sliding it into the front mounting plate, as it cannot be attached when up-side down. Use moderate pressure to fully seat the panel into position.
2. To verify correct panel installation, swing the panel assembly up into position until it locks easily into place. If any resistance is encountered, re-check panel orientation in chassis mounting plate.
3. When taking the front panel with you, please use the supplied carrying case to protect the panel from dirt and damage. Make sure there is no dust or dirt on the electrical terminals on the back of the panel as this could cause intermittent operation or other malfunctions.

NOTES ON USE OF REMOTE INPUT JACK:

The remote input jack provides the user option of applying an external audio source to the radio. The audio jack is compatible with most "Walkman" CD and cassette players, or an MP3 digital audio playback unit. When the external source is connected, only that media is played by the radio; no other input sources (radio or CD) are operative.

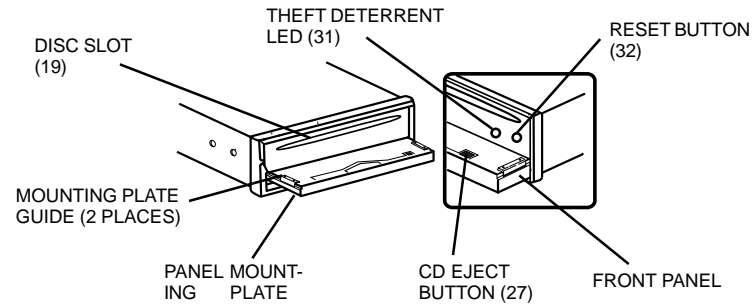

SETTING THE CLOCK

1. Switch the vehicle ignition and radio "on".
2. Press the Display (T/F) button to call the time display; then press and hold the button until a beep tone occurs and the time display flashes.
3. While the display is flashing, press the Up TUNE/SEEK/TRACK (▶▶) button to adjust the hours and **A or P** indication, or the Down TUNE/SEEK/TRACK (◀◀) button to adjust the minutes to the correct time.
4. Five seconds after the last hour or minute adjustment is made, the time will be set in the unit and the display will return to the normal indication.

CD PLAYER ERROR CODES

If a problem should develop while operating the CD player, an error code (**ER-1**, **ER-2**, **ER-3**, etc.) may appear on the display panel. This can indicate a number of problems with the unit, including a mechanical error or an error in the microprocessor control of the player. If an error code should appear, try ejecting and reloading the disc into the player. While the disc is out of the unit, make sure it is clean, undamaged, and loaded correctly (label surface up). You may also try activating the RESET button ⑳ on the unit, but this will also erase the time and pre-set memories.

If the suggested measures do not solve the problem, contact an approved warranty station near you for further assistance.

SPECIFICATIONS

Size: 7" W x 2" H x 6-1/4"D
178 mm x 50 mm x 158 mm

Operating Voltage: 12 volts DC, negative ground

Fuse Ratings: Constant (Yellow wire): 15 AMP.
Switched (Red wire): 0.5 AMP.

Output Power: 160 watts maximum
(40 watts x 4 channels)

Output Wiring: Floating-ground type designed
for 4 speaker use.
Front and rear channels CAN NOT
be combined (bridged) for use with
2 speakers.
RCA low-level outputs (front and
rear channels).

Output Impedance: Compatible with 4 – 8 ohm
speakers.

Low-Level Output: 0.7 Volt.

Tuning Range: AM: 520 – 1,710 kHz.
(10 kHz. step)
FM: 87.5 – 107.9 MHz.
(200 kHz. step)

Sensitivity: AM: 20 uV.
FM: 5.0mV.

FM Stereo Separation: 25 kHz

CD Frequency Response: 20Hz – 20 kHz. +/-3dB

CD Signal/Noise Ratio: ≥ 60 dB

CD Channel Separation: ≥ 50 dB

CD Dynamic Range: ≥ 60 dB

*Specifications are subject to change without notice.

CD CHANGER CONTROLS

Built into this radio are controls to operate an optional CD changer. Please check with your Prestige/Audiovox car stereo specialist or call 1-800-645-4994 for recommendations of the models that will work with this radio.

Adjustment of the audio functions (volume, tone, balance, and fader) for the CD changer operate in the same manner as they do for radio play. The following controls will operate the CD changer when it is installed and connected to this radio. Refer to the owner's manual included with the CD changer for instructions on the installation and correct loading and use of the CD magazine.

35 CD CHANGER MODE SELECTOR (MODE)

During radio or CD play, press this button to select operation of the CD changer as shown by **CDC** on the display panel. Disc play will begin and the disc and track number will be shown on the display panel. When the magazine is loaded into the changer, play will begin from the first track of the first disc in the magazine.

36 DISC SELECT (D.UP/D.DN)

These buttons are used to select the desired disc for play. To advance to a higher number disc, press the D.UP button. To return to a lower number disc, press the D.DN button. The number of the disc in play will be shown on the display panel.

37 TRACK SELECT (▶▶/◀◀)

The Track Select functions are used to quickly access the beginning of a particular track. Each time the Forward Track Select (▶▶) button is pressed, the next higher track number will be selected as shown on the display panel. Similarly, each time the Backward Track Select (◀◀) button is pressed, the next lower track number will be selected as shown on the display panel.

38 CUE/REVIEW FUNCTIONS (▶▶/◀◀)

High-speed audible search to any section of the disc can be made by the Cue and Review functions. Repeatedly press the Cue (▶▶) side of the button to advance rapidly in the forward direction (disc play symbol rotation on the display panel will stop), or the Review (◀◀) side of the button to advance rapidly in the backward direction.

39 TRACK/DISC SCAN SELECTOR (SCN)

When the SCN button is pressed, the **SCN** indication will appear on the display panel, and the first 10 seconds of each track on the disc will be played in order. When a desired track is reached, press the SCN button again, and play of the selected track will continue (**SCN** will disappear from the display panel). The Track Scan mode will also be canceled by activating the Repeat or Shuffle Play functions.

When the SCN button is pressed and held, the **DSN** indication will appear on the display panel and the first 10 seconds of the first track on each disc in the magazine will be played. When a desired disc is reached, press the SCN button again and play of the selected disc will continue (**DSN** will disappear from the display panel). The Disc Scan mode will also be canceled by activating the Repeat Play or Shuffle Play functions.

40 DISC/TRACK REPEAT PLAY (RPT)

When the RPT button is pressed, the **RPT** indication will appear on the display panel and play of the selected track will be continually repeated until the Track Repeat mode is canceled by pressing the RPT button twice, or by activating the Scan or Shuffle Play functions.

When the Repeat button is pressed and held, the **DRT** indication will appear on the display panel and play of the selected disc

will be continually repeated until the Disc Repeat mode is canceled by pressing the RPT button again or by activating the Scan or Shuffle Play functions.

41 DISC/TRACK SHUFFLE PLAY (SHF)

When the SHF button is pressed, the **SHF** indication will appear on the display panel and the tracks on the disc will be played in a random, shuffled order. The Track Select button will also select tracks in the shuffled order instead of the normal progression. The Random Track mode can be canceled by pressing the SHF button or by activating the Scan or Repeat Play functions.

When the SHF button is pressed and held, the **DSF** indication will appear on the display panel and the discs in the magazine will be played in a random, shuffled order, as well as the tracks on each disc. After playing all tracks selected at random from a disc in the magazine, the unit will select another disc at random and play all the tracks on it in a random shuffled order. This will continue from disc-to-disc until the Random Disc mode is canceled by pressing the **SHF** button again or by activating the Scan or Repeat Play functions.

CD CHANGER ERROR CODES

If a problem should develop while operating the CD changer, the following error codes may appear on the display panel.

ER-1: Indicates that there is no magazine loaded in the CD changer.

ER-2: Indicates a problem with the magazine eject function.

ER-3: Indicates an error in the disc loading function.

ER-4: Indicates an error in the disc unloading function.

ER-5: Indicates an error in the magazine position.

ER-6: Indicates an error in the laser pick-up position.

ER-7: Indicates an error in the laser focus on the disc.

In any of these error situations, try ejecting the CD magazine from the changer and make sure the discs are clean, undamaged, and loaded correctly (refer to the Owner's Manual of the CD changer). Re-load the magazine and check for proper operation. You may also try activating the RESET button **32** on the unit, but this will also erase the time and pre-set memories. If the suggested measures do not solve the problem, contact an approved warranty station near you for further assistance.

WIRELESS REMOTE CONTROL OPERATION

The wireless remote control supplied with this model is capable of operating most of the features of the unit from a remote location. Each button on the remote control functions in the same way as the referenced button on the main unit. For optimal operation of the remote control, always aim it toward the Remote Sensor ③④ on the front panel of the main unit.

- ① **POWER** - See Main Unit ①
- ② **VOLUME (LEVEL) CONTROL**- See Main Unit ②, ③ ④, ⑤, ⑥, and ⑦ except press VOL + to increase level, and press VOL - to decrease level
- ③ **SELECT BUTTON (S)** - See Main Unit ③, ④, ⑤, ⑥, and ⑦
- ④ **PRE-SET SCAN-AUTO STORE TUNING**- See Main Unit ⑩
- ⑤ **AM/FM BAND SELECTOR (BAND/ENTER)** – See Main Unit ⑩
- ⑥ **UP/DOWN TUNE/SEEK/TRACK (9/8)** – See Main Unit ⑪
MANUAL SEEK TUNING – See Main Unit ⑪, except press ►► to seek upward and press ◄◄ to seek downward.

CD TRACK SELECT – See Main Unit ⑳ and ③⑦ except press ►► to select a higher track number, press ◄◄ to select a lower track number.

CD CUE/REVIEW – See Main Unit ㉑ and ③⑧ except press ►► for Cue function, and press ◄◄ for Review function.

- ⑦ **RADIO PRE-SET MEMORY 1-6** - See Main Unit ⑮
- ⑧ **DISC UP SELECT (D.UP)** - See Main Unit ⑳
- ⑨ **DISC DOWN SELECT (D.DN)** - See Main Unit ㉑
- ⑩ **TRACK/DISC REPEAT (RPT)** - See Main Unit ㉒ and ④⑩
- ⑪ **TRACK/DISC SHUFFLE (SHF)** - See Main Unit ㉓ and ④⑪
- ⑫ **TRACK/DISC PAUSE (PAU)** - See Main Unit ㉔
- ⑬ **TRACK/DISC SCAN (SCN)** - See Main Unit ㉕ and ④⑫
- ⑭ **MODE SELECTOR (MODE/7)** - See Main Unit ⑰ and ④⑬
- ⑮ **TIME/FREQUENCY SELECT BUTTON (T/F)/0**- See Main Unit ㉖
- ⑯ **INFRARED SENDER** - Emits infrared signal to radio which is detected by the sensor ③④
- ⑰ **BATTERY COMPARTMENT** - Holds two AAA batteries for remote wireless control operation.

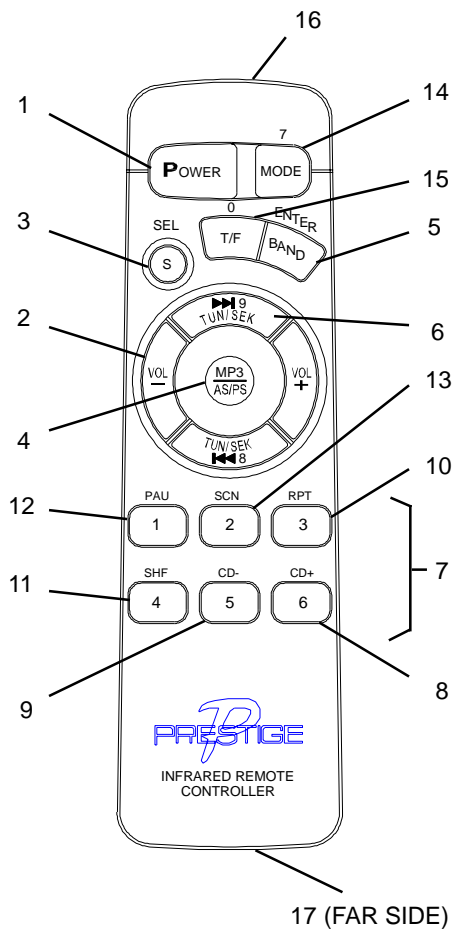

PLAYING MP3 MUSIC FILES

MP3 (Moving Picture Experts Group, Layer 3) are digital audio files that are compressed to about 1/10th the size of a CD recording. As a result, you can compress a CD song that has 50 megabytes of data into an MP3 that has only 4 or 5 megabytes.

The P-953 can play MP3s directly from files contained on a CD-R/RW, by using the MP3 buttons on the radio (or Remote Control).

MP3 CONTROLS

The following buttons represent control inputs, characters and/or numbers dedicated to the access of files on your MP3 CD.

1. **AS/PS:** The AS/PS button, also labeled **MP3**, is used to search and/or access the Track Number and Directory/Album title; additional presses will momentarily access the disc serial number (if applicable), and display the current Directory/Album title. By using this button, you can quickly jump to a Directory/Album and then navigate within that area to locate and play a specific song/track.
2. **BAND/LOUD:** The BAND/LOUD button is also labeled **ENTER** for MP3 CD playback purposes; its function permits entry to the desired Directory/Album or Track after being accessed by the **MP3** (AS/PS) button.
3. **Preset 1:** During MP3 disc play, pressing this button in conjunction with the MP3 button, will select track number 1, or a track number containing this numeral. When a Directory or song title search is being made, this button also represents alphanumerical characters **A, B, C, 1**. Pressing the button consecutively scrolls through the characters.
4. **Preset 2:** This button functions in the same manner as Preset 1, except it represents alphanumerical characters **D, E, F, 2**.
5. **Preset 3:** This button functions in the same manner as Preset 1, except it represents alphanumerical characters **G, H, I, 3**.

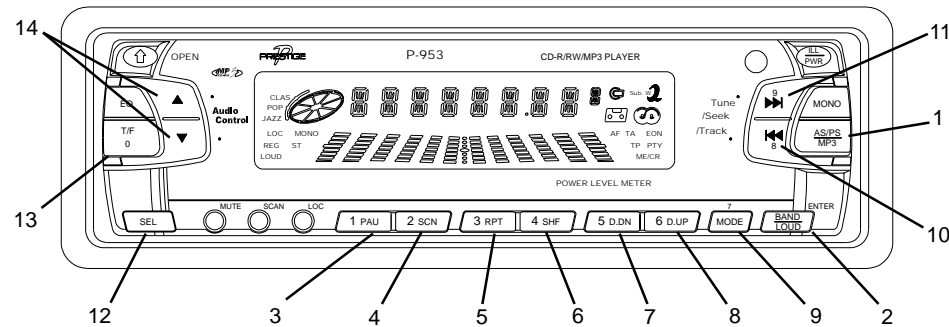

6. **Preset 4:** This button functions in the same manner as Preset 1, except it represents alphanumeric characters **J, K, L, 4**.
7. **Preset 5:** This button functions in the same manner as Preset 1, except it represents alphanumeric characters **M, N, O, 5**.
8. **Preset 6:** This button functions in the same manner as Preset 1, except it represents alphanumeric characters **P, Q, R, 6**.
9. **MODE:** This button functions in the same manner as Preset 1, except it represents alphanumeric characters **S, T, U, 7**.
10. **MANU/SKIP (Down):** This button functions in the same manner as Preset 1, except it represents alphanumeric characters **V, W, X, 8**.
11. **MANU/SKIP (Up):** This button functions in the same manner as Preset 1, except it represents alphanumeric characters **Y, Z, Space, 9**.
12. **Select (SEL):** This button is used in conjunction with the MP3 button and AUDIO CONTROL knob to confirm selection of the alphanumeric character when choosing a specific Directory/ Album and/or song title.
13. **Time/Frequency (T/F):** This button functions in the same manner as Preset 1, except it represents symbol/numeric characters **→, -, +, 0**.

14. **AUDIO CONTROL Up/Down:** The AUDIO CONTROL buttons perform the same function as the other alphanumeric buttons when choosing a specific Directory/Album and/or song title; it allows quick selection and entry of sequential Alphanumeric characters when used in conjunction with the SEL button which confirms each selected character before moving on to the next one.

NOTE: The D.DN (**Preset 5**) and D.UP (**Preset 6**) buttons also enable track selection in 10-track steps during normal CD play and when searching for files or directories.

LOADING AN MP3 DISC

As with a normal music CD, when an MP3 disc is initially loaded, **S--CDP** appears on the display for 5 seconds. The (CD) indication illuminates and becomes animated, the ⊖ symbol lights; then **MP3 T** and the track number momentarily appear, followed by the ID Tag, if supported, and READING on the display.

ACCESSING THE ID TAG

To access the ID tag, when supported, proceed as follows:

1. Press the MP3 (AS/PS) button until the ID Tag, if supported, is displayed.

NOTE: The ID TAG can specify the **Songname, Artist, Album, Year, and/or Comments.**

2. If no ID TAG is available, **--NO ID3** will appear on the display following **Comments.**

SEARCHING THE TRACK DIRECTLY

To search for a desired track directly, proceed as follows:

1. With the MP3 CD in the play mode, press the MP3 (AS/PS) button; **MP3 T** appears on the display followed by a flashing character position (**X**); then press the direct numeric key or combination thereof, to access the appropriate track.
2. If the desired track number consists of two digits or less, the player will wait a few seconds for the ENTER (BAND/LOUD) button to be pressed; otherwise, the player will begin searching for the track automatically.
3. When the track is accessed, the track number appears on the display, followed by the song name.

SEARCHING FOR A DIRECTORY OR FILE

To search for a desired directory or file on the MP3 CD, proceed as follows:

1. With the MP3 CD in play mode, press the MP3 button until only a blinking character position (**X**) appears.
2. Then press the desired buttons, or use the AUDIO ADJUST control with the SEL button, to enter characters of the directory or file name. Up to 8 alphanumeric characters can be entered for search.
3. Press the ENTER (BAND/LOUD) button to access the directory.

NOTE: If the Directory/File is entered incorrectly, or does not exist, **NOT FOUND** will be displayed momentarily.

4. Then continue the search within the directory for the song title by using the **▶▶| / ◀◀** buttons, but use the **◀◀** button first.
5. When the title is accessed, press the ENTER button again to begin play of the selected song.

NAVIGATING FROM A ROOT DIRECTORY

To search for a desired song from a root directory on the MP3 CD, proceed as follows:

1. With the MP3 CD in play mode, press the MP3 button until the root name is displayed for a second and the first directory or file name is displayed (selected).
2. If the selected name is in the directory, go into the selected directory by pressing the ENTER (BAND/LOUD) button.
3. Then continue the search within the directory for the song title by using the **▶▶| / ◀◀** buttons, but use the **◀◀** button first.
4. When the song title is accessed, press ENTER again to begin play of the selected song.

NAVIGATING FROM A CURRENT DIRECTORY

To search for a desired song from the current directory on the MP3 CD, proceed as follows:

1. With the MP3 CD in play mode, press the MP3 button until the root name is displayed for a second and the currently playing file name is displayed (selected).
2. If the displayed name is the desired directory or the file in the directory, go into the selected directory and play the file by pressing the ENTER (BAND/LOUD) button.
3. Otherwise, continue the search within the directory for the song title by using the **▶▶| / ◀◀** buttons, but use the **◀◀** button first.
4. When the song title is accessed, press ENTER again to begin play of the selected song.

NOTES ON DISCS:

Attempting to use non-standard shape discs (e.g.; square, star, heart) may damage the unit. Be sure to use round-shape CDs only in this unit.

NOTES ON CD-Rs (Recordable CDs)/CD-RWs (Rewriteable CDs):

1. Be sure to use discs with the following marks only for play in this unit:



2. The unit cannot play a CD-R or CD-RW that is not finalized. (Please refer to the manual of your CD-R/CD-RW software for more information on the finalization process.)
3. Depending on the recording status, conditions of the disc and the equipment used for the recording, some CD-Rs/CD-RWs may not be played on this unit.

NOTES ON MULTI-SESSION DISCS:

1. If the first track of the first session is audio CD data, then the unit will play only the audio CD data.
2. When the first track of the first session is not audio CD data, but an MP3 file is included on the disc, then only the MP3 files will be played back and other data (including CD data) is skipped.

CARE AND MAINTENANCE

The radio section of your new sound system does not require any maintenance. We recommend you keep this manual for reference on the many features found in this unit as well as how to set the clock.

The compact disc player section also requires no routine maintenance, but proper understanding of its use and handling will help you obtain maximum enjoyment of its capabilities. The following points should be observed:

- When cleaning the interior of the vehicle, do not get water or cleaning fluids on the unit.
- The CD player is a precision instrument and will not operate properly in extreme hot or cold. In case of such conditions, wait until the interior temperature of the vehicle reaches a normal temperature before using the player.
- If the temperature inside the player gets too hot, a protective circuit will automatically stop play of the disc. In this case, allow the unit to cool off before operating the player again.
- Never insert anything other than a 5" (12 cm) compact disc into the player as the mechanism can be damaged by foreign objects.
- Do not attempt to use 3" (8 cm) CD-Single discs in this unit, either with or without an adaptor, as damage to the player and/or disc may occur. Such damage will not be covered by the Warranty on this product.
- When not using the disc player, always remove the compact disc.

- When the vehicle warms up during cold weather or under damp conditions, moisture may condense on the lens of the disc player. Should this occur, the player will not operate properly until the moisture has evaporated.
- The unit is designed with a vibration dampening CD mechanism to minimize interruption of disc play due to normal vibration in a moving vehicle. When driving on very rough roads, however, occasional sound skips may occur. This will not scratch or damage the disc and normal play will resume when the rough conditions cease.

HANDLING COMPACT DISCS

Dirt, dust, scratches, and warpage can cause skips in the playback and deterioration of sound quality. Please follow these guidelines to take care of your compact discs:



- Use only compact discs with the mark .
- Fingerprints, dust, and dirt should be carefully wiped off the disc's playing surface (shiny side) with a soft cloth. Wipe in a straight motion from the inside to the outside of the disc.
- Never use chemicals such as record sprays, household cleaners or thinner to clean compact discs. Such chemicals can irreparably damage the disc's surface.
- Discs should be kept in their storage cases when not in use.
- Do not expose discs to direct sunlight, high temperatures or high humidity for extended periods.
- Do not stick paper, tape, or labels on the disc surfaces nor write on them with any type of marker.



12 / 24 MONTH LIMITED WARRANTY

Applies to automotive radios, radio/tape players, radio/CD players, CD changers, power amplifiers, equalizers and accessories.

AUDIOVOX CORPORATION (the Company) warrants to the original retail purchaser of this product that should this product or any part thereof, under normal use and conditions, be proven defective in material or workmanship within 12 months from the date of original purchase, such defect(s) will be repaired or replaced with new or reconditioned product (at the Company's option) without charge for parts and repair labor.

To obtain repair or replacement within the terms of this Warranty, the product is to be delivered with proof of warranty coverage (e.g. dated bill of sale), specification of defect(s), transportation prepaid, to an approved warranty station or the Company at the address shown below.

The warranty period will be extended to 24 months from the date of original purchase if the product is installed by an authorized Prestige Audio dealer. To claim warranty service during this extended period, the bill of sale must specify that the product was installed by an authorized Prestige Audio dealer.

This Warranty does not extend to the elimination of externally generated static or noise, to correction of antenna problems, to costs incurred for installation, removal or reinstallation of the product, or to damage to tapes, compact discs, speakers, accessories, or vehicle electrical systems.

This Warranty does not apply to any product or part thereof which, in the opinion of the Company, has suffered or been damaged through alteration, improper installation, mishandling, misuse, neglect, accident, or by removal or defacement of the factory serial number/bar code label(s). THE EXTENT OF THE COMPANY'S LIABILITY UNDER THIS WARRANTY IS LIMITED TO THE REPAIR OR REPLACEMENT PROVIDED ABOVE AND, IN NO EVENT, SHALL THE COMPANY'S LIABILITY EXCEED THE PURCHASE PRICE PAID BY PURCHASER FOR THE PRODUCT.

This Warranty is in lieu of all other express warranties or liabilities. ANY IMPLIED WARRANTIES, INCLUDING ANY IMPLIED WARRANTY OF MERCHANTABILITY, SHALL BE LIMITED TO THE DURATION OF THIS WRITTEN WARRANTY. ANY ACTION FOR BREACH OF ANY WARRANTY HEREUNDER INCLUDING ANY IMPLIED WARRANTY OF MERCHANTABILITY MUST BE BROUGHT WITHIN A PERIOD OF 30 MONTHS FROM DATE OF ORIGINAL PURCHASE. IN NO CASE SHALL THE COMPANY BE LIABLE FOR ANY CONSEQUENTIAL OR INCIDENTAL DAMAGES FOR BREACH OF THIS OR ANY OTHER WARRANTY, EXPRESS OR IMPLIED, WHATSOEVER. No person or representative is authorized to assume for the Company any liability other than expressed herein in connection with the sale of this product.

Some states do not allow limitations on how long an implied warranty lasts or the exclusion or limitation of incidental or consequential damage so the above limitations or exclusions may not apply to you. This Warranty gives you specific legal rights and you may also have other rights which vary from state to state.

U.S.A. : AUDIOVOX CORPORATION, 150 MARCUS BLVD., HAUPPAUGE, NEW YORK 11788 • 1-800-645-4994

CANADA : CALL 1-800-645-4994 FOR LOCATION OF WARRANTY STATION SERVING YOUR AREA

128-5543

© 2002 AUDIOVOX ELECTRONICS CORP., HAUPPAUGE, NY

Printed in China

128-6356